



Compact Immunity Test System

CCS 800

- IEC/EN 61000-4-4
- IEC/EN 61000-4-5
- IEC/EN 61000-4-8
- IEC/EN 61000-4-9
- IEC/EN 61000-4-11
- IEC/EN 61000-4-12
- IEC/EN 61000-4-29
- IEC/EN 61008-1
- IEC/EN 61009-1
- EN 61543
- GB/T 17626.4
- GB/T 17626.5
- GB/T 17626.8
- GB/T 17626.9
- GB/T 17626.11
- GB/T 17626.12
- GB/T 17626.29
- ANSI/IEEE C62.41

Features

- > 5.7-inch color touch screen front panel operation;
- > Surge failure detection function;
- > Surge voltage and current measurement and acquisition;
- > Test the orchestration function;
- > Built in multifunctional testing module combination;
- > Built in fully automatic single-phase coupling/decoupling network AC 300V 20A/32A, DC 300V 20A/32A;
- > Can control external three-phase coupling/decoupling network and other functional modules;
- > Ethernet and RJ45 interfaces, used for PC remote control and printing test reports.

Introduction

CCS 800 is an intelligent multifunctional combined immunity testing (EMS) equipment that can meet various testing requirements for transient pulses, surges, communications, voltage drops, ringing waves, pulse magnetic fields, and power frequency magnetic fields according to international standards and product series standards. The maximum testing voltage can reach 8kV.

CCS 800 is the best choice for fully compatible immunity testing solutions. Meets the anti-interference testing requirements of EU CE certification and CCC certification for single-phase test equipment, with a built-in fully automatic single-phase coupling/decoupling network, and can also perform three-phase five wire test equipment testing through an automatically controlled external coupling/decoupling network (up to 400A). We provide you with various testing accessories to meet various application needs such as power frequency magnetic field testing

Application Areas



General Parameters

Display	5.7-inch TFT touch screen
Scope of Working Power Supply	100 ~ 264 V AC, 47 ~ 63 Hz
Fuse	6 A
Maximum Power Consumption	300 W
Communication Method	Ethernet LAN
External Control Mode	25 needle parallel thread
External Trigger Input	BNC, 5V TTL
CRO Triggers Output	BNC, 5V TTL
Operation Control Input	BNC, 5V TTL
Pulse Triggering Method	Manual, automatic, externally triggered
External Synchronous Input	20 ~ 400 V, 45 ~ 65 Hz
Warning Light Output	Multi core connector output, matched with external alarm light module (optional)
Safety Circuit	Short circuit of safety loop, stop working when the safety loop is open circuit
Failure Detection	When it fails, the front panel LCD displays and interrupts the instrument's operation
Instrument Working Status Indication	LED indication, LCD display
Instrument Grounding Connection Method	Use a flat grounding wire
Chassis Size	19 inches/8U L * W * H: 650 * 445 * 371 mm
Instrument Weight	About 65 kg
Environmental Scope	15°C ~ 35°C
Pressure Range	86 kPa ~ 106 kPa
Humidity Range	45% ~ 75%

Built in coupling /decoupling network (single-phase fully automatic)

EUT Carrying Capacity	AC 300 V 20 A/32 A (optional) 50/60 Hz
	DC 300 V 20 A/32 A (optional)
EUT Power Input and Output	4mm banana plug cable
EUT Voltage Monitoring Output	BNC output, 100V: 1V
EUT Current Monitoring Output	BNC output, 10 A: 1 V
Synchronization Method	Internal synchronization, external synchronization, asynchronous
Internal Synchronization	0 °~360 °, 1 ° step setting or random mode
Pulse group Coupling/decoupling	Built in single-phase automatic coupling/decoupling network
1.2/50 μs Combined Wave Coupling/decoupling	Built in single-phase automatic coupling/decoupling network
Ringing Wave Coupling/decoupling	Built in single-phase automatic coupling/decoupling network

IEC-61000-4-4 Electrical Fast Transient Pulse Test

Source Port Test Voltage Range	0.25 kV ~ 6 kV ($\pm 10\%$)
Network Port Test Voltage Range	0.25 kV ~ 5.5 kV ($\pm 10\%$)
50 Ω Calibration Waveform	5 ± 1.5 ns, 50 ns ± 15 ns
1000 Ω Calibration Waveform	5 ± 1.5 ns, 50 ns(- 15 / + 100 ns)
Pulse Frequency	0.1 kHz ~ 1000 kHz
Pulse Group Period	11 ms ~ 9999 ms
Pulse Train Duration	0.075 ms ~ 750 ms
Experimental Mode	Optional scheduling mode
Polarity	Positive, negative, first positive and then negative
Coupling Capacitor	33 nF

IEC-61000-4-5 Surge Immunity Test

Test Voltage	0.25 kV ~ 8 kV ($\pm 10\%$)
Test Current	0.125 kA ~ 4 kA $\pm 10\%$
Voltage Waveform	$1.2 \mu\text{s} \pm 30\%$, $50 \mu\text{s} \pm 20\%$
Current Waveform	$8 \mu\text{s} \pm 20\%$, $20 \mu\text{s} \pm 20\%$
Output Impedance	2 Ω , 12 Ω
Test Interval Time	6 ~ 99 s (the shortest depends on the test voltage)
Number of Experiments	1~999 times
Experimental Mode	Optional scheduling mode
Polarity	Positive, negative, first positive and then negative
Calibration Capacitor	18 μF built-in
Coupling Resistance	0 Ω , 10 Ω
Coupling Capacitor	Built in at 9 μF and 18 μF
Surge Voltage Peak Detection	LCD display, BNC output 1000V: 1V
Surge Current Peak Detection	LCD display, BNC output 500A: 1 V

IEC-61000-4-5 Communication Wave Test

Test Voltage	0.25 kV ~ 8 kV ($\pm 10\%$)
Test Current	6.25 A ~ 200 A $\pm 10\%$
Voltage Waveform	10 μ s $\pm 30\%$, 700 μ s $\pm 20\%$
Current Waveform	5 μ s $\pm 20\%$, 320 μ s $\pm 20\%$
Output Impedance	15 Ω , 40 Ω
Test Interval Time	6 ~ 99 s (the shortest depends on the test voltage)
Number of Experiments	1~999 times
Experimental Mode	Optional scheduling mode
Polarity	Positive, negative, first positive and then negative

IEC-61000-4-8 Power Frequency Magnetic Field Test

Module	MFT series
Magnetic Field Intensity	TCXS 111 single turn magnetic field coil
	1 A/m~100 A/m (continuous) 100 A/m~400 A/m (1 s~10 s short-term)
	TCXS 113 three turn magnetic field coil:
	1 A/m~300 A/m (continuous) 300 A/m~1200 A/m (1~10s short-term)
Current Waveform	50 Hz/60 Hz sine wave
Current Distortion Rate	< 5%
Generator Output Current	1 A ~ 450 A
Waveform Interval Time	1 s ~ 9999 s
Test Duration	1 s ~ 28800 s
Magnetic Field Coil Size	1 m x 1 m, other
Shape of Magnetic Field Coil	Rectangle, Other
Output Magnetic Field Strength	Scheduling Settings

IEC-61000-4-9 Pulse Magnetic Field Test

Magnetic Field Strength (1*1 m coil)	100 A/m ~ 1200 A/m
magnetic Field Strength (1*2.6 m coil)	100 A/m ~ 880 A/m
Coil Waveform (1*1 m Single Turn)	8 μ s(+ 2.4 μ s /- 0.8 μ s), 20 μ s(+ 6 μ s/-2 μ s)
Coil Waveform (1*2.6 m Single Turn)	8 μ s(+ 3.2 μ s/- 0.8 μ s), 20 μ s(+ 8 μ s/-2 μ s)
Test Interval Time	5 ~ 99 s(the shortest depends on the magnetic field strength)
Number of Experiments	1~999 times
Experimental Mode	Optional scheduling mode
Polarity	Positive, negative, first positive and then negative
Magnetic Field Coil Size	1 m x 1 m, other
Shape of Magnetic Field Coil	Rectangle, other









IEC-61000-4-11 & IEC-61000-4-29 Cycle Drop Test

Module	VVT series
EUT Carrying Capacity	AC 300 V 20 A/32 A (optional) 50/60 Hz DC 100~300 V 20 A/32 A (optional)
EUT Voltage Frequency	45 ~ 65 Hz
100 Ω Calibration Waveform (Communication Loss)	1 ~ 5 μ s
100 Ω Calibration Waveform (DC Drop)	1 ~ 50 μ s
Impulse Current	500 A
Interrupt Level	0%
Temporary Voltage Drop	0%~100% (applicable to attachment VVT/VMT series)
Duration of Temporary Descent and Interruption	0.3~9999 cycles or 1ms~9999ms
Temporary Reduction and Interruption Interval Time	50 ms ~ 50000 ms
Temporary Reduction and Interruption of Test Frequency	1 ~ 9999 times
Temporary Descent, Interruption of Ascent, Descent time	1~5 μ s (100 Ω load)



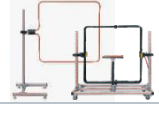

IEC-61000-4-12 Ringing Wave Test

Open Circuit Output Voltage (PK1)	0.25 kV ~ 8 kV $\pm 10\%$
Open Circuit Voltage Oscillation Frequency (1/T)	100 kHz $\pm 10\%$
Before the Waveform of Open Circuit Voltage (T1, 10%-90%)	PK1 0.5 μs $\pm 30\%$
Open Circuit Voltage Decay Rate	40% < (PK2)/(PK1) < 110%, 40% < (PK3)/(PK2) < 80%
	40% < (PK4)/(PK3) < 80%
Short Circuit Current Wave Front (T2, 10% -90%)	0.2 μs \leq Pk1 \leq 1 μs
Open Circuit Voltage (PK1) 8000 V When, Short-circuit Current (P1)	666 A $\pm 10\%$ at 12 Ω ; 266 A $\pm 10\%$ at 30 Ω
Output Impedance	12 Ω , 30 Ω
Test Interval Time	6 ~ 99 s
Pulse Frequency	1~999 times
Experimental Mode	Optional scheduling mode
Polarity	Positive, negative, first positive and then negative

CCS 800 Selection Guide List

Host	Compact Immunity Test System CCS 800	IEC 61000							CDN single-phase three wire network
		- 4-4	- 4-5	- 4-8	- 4-9	- 4-11	- 4-12	- 4-29	
		✓	✓		✓	✓	✓	✓	✓
Optional module									
	Power frequency magnetic field module MFT 400 / 1200			✓					Can root according to EUT electric Pressure the electric flow etc. level want seek set system
	AC power supply temporary drop, short-term interruption, voltage change module VVT 2216S / SV					✓			
	Power failure and power frequency magnetic field module VMT 2216S / SV			✓		✓			
	Pulse group coupling/ Decoupling network EFTN xxxxT series	✓							
	Lightning surge coupling/Decoupling network SPN xxxxT10 series		✓				✓		
	Surge and group pulse coupling/ decoupling network SEPN xxxxT10 series	✓	✓				✓		
	Magnetic field coil TCXS series			✓	✓				
	Capacitive coupling clamp CCC 100(SHV connection terminal)	✓							
<p>Note: If only the host is selected and VVT or VMT testing modules are not available, an additional power supply is required for IEC 61000-4-11/29 testing</p>									

List of Testing and Measurement Selection Guidelines

Instrument name and model		IEC 61000						
		- 4 - 4	- 4 - 5	- 4 - 8	- 4 - 9	- 4 - 11	- 4 - 12	- 4 - 29
	High voltage differential probe VCF 80		✓			✓	✓	✓
	Broadband current monitoring clamp CM 0220M		✓		✓		✓	
	10 kV surge calibration module CCM 1000		✓					
	EFT pulse train generator calibration device TFB 500 / 1000	✓						
	Immunity testing software CoreLab	✓	✓	✓	✓	✓	✓	✓

Naming Rules

CCS XXX (BSTDR-300-32)

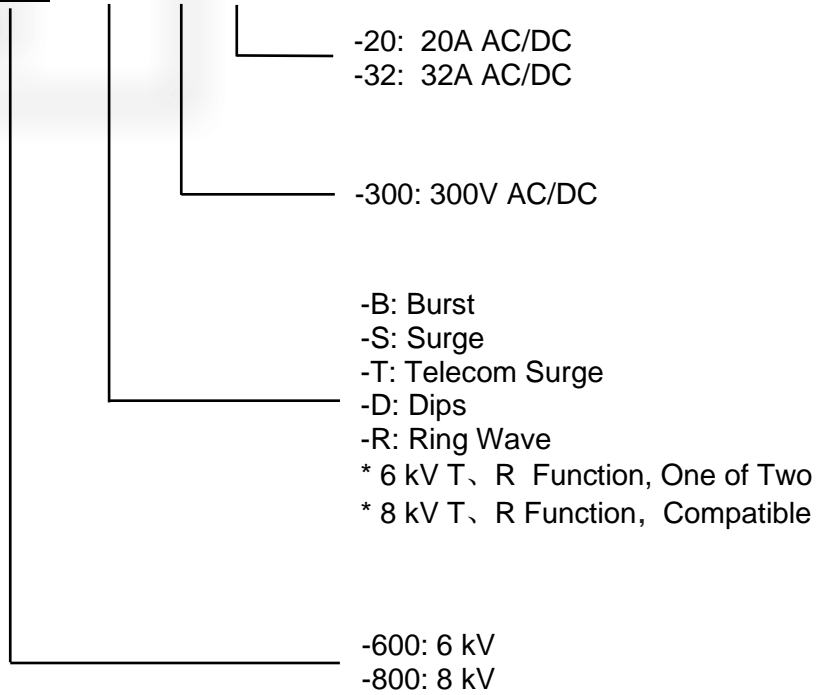

Note: Pulse magnetic field, power frequency magnetic field, drop accessories, coils, external networks and other accessories have independent models and are not reflected in the host model.

SUZHOU3CTEST ELECTRONIC CO., LTD

Address: No. 99 E'meishan Road, SND, Suzhou, Jiangsu Province, China
Sales Email: globalsales@3ctest.cn Service Email: service@3ctest.cn
Tel: + 86 - 512 - 68077192 Web: www.3c-test.com

